

## Identification of Steroids in Urine and Plasma by LC/MS/MS using strata™X and Gemini™ C18

Liming Peng, Tivadar Farcas, and Michael McGinley  
Phenomenex Inc., Torrance, CA, USA

### Introduction

Corticosteroids are an important class of compounds that have uses as therapeutic agents as well as some illicit uses. Steroid hormones are widely used throughout the body and are involved in numerous regulatory pathways including immune response, sexual differentiation, and metabolic function.

*“Testing has become more challenging due to the use of drug-masking agents by athletes . . . to cover their steroid use”*

While steroids may often be the most effective treatment for a particular condition, widespread systemic responses often requires drug monitoring to minimize numerous side effects.

**Figure 1: Structure of Several Key Steroids**

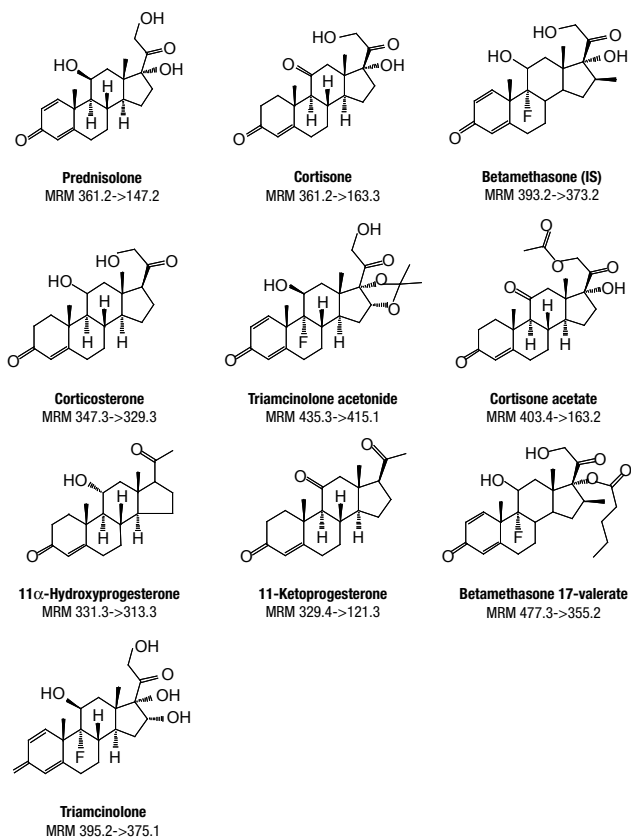
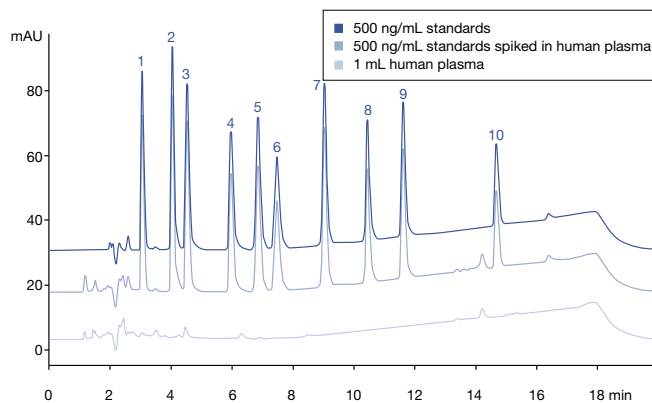

**Figure 1:** Structure of 10 common steroids. Also listed are MRM transitions used for MS/MS detection.

A particular example revolves around immune response; steroids are very potent anti-inflammatory drugs and in many cases closely monitored, especially for patients with autoimmune disorders.

Illicit steroid usage has continued to increase as a performance enhancer for athletes over the years. Such widespread abuse of steroids has led to a dramatic increase in drug testing of athletes by regulatory agencies. This testing has become more challenging due to the use of drug-masking agents by athletes in an attempt to cover their steroid use. Such interferences make chemical and ELISA-based tests sometimes impractical for accurate detection. The combination of mass spectroscopy, improved chromatography separations and efficient sample preparation by SPE allows for a specific, sensitive and accurate method for detection of steroid usage. Methods using a high capacity polymeric SPE sorbent, (strata™X) and advanced HPLC column (Gemini™ C18) deliver an accurate and sensitive means for the quantification of steroids in urine and plasma samples.

**Figure 2. Corticosteroids in Human Plasma by HPLC-UV**



**Figure 2:** HPLC Chromatogram of steroid standards in human plasma. 5 µg/mL of each steroid is injected and monitored at 254 nm. Note the baseline separation of key steroids in less than 20 minutes. (Peaks: 1. Triamcinolone, 2. Prednisolone, 3. Cortisone, 4. Betamethasone (IS), 5. Corticosterone, 6. Triamcinolone acetonide, 7. 11α-Hydroxyprogesterone, 8. Cortisone acetate, 9. 11-Ketoprogesterone, 10. Betamethasone 17-valerate)



[www.phenomenex.com](http://www.phenomenex.com)  
Phenomenex products are available worldwide. For the distributor in your country, contact Phenomenex USA, International Department by telephone, fax or e-mail: [international@phenomenex.com](mailto:international@phenomenex.com).

**phenomenex**  
...breaking with tradition™

**USA**  
tel.: (310) 212-0555  
fax: (310) 328-7768  
email: [info@phenomenex.com](mailto:info@phenomenex.com)

**Puerto Rico**  
(800) 541-HPLC  
(310) 328-7768  
[info@phenomenex.com](mailto:info@phenomenex.com)

**Canada**  
(800) 543-3681  
(310) 328-7768  
[info@phenomenex.com](mailto:info@phenomenex.com)

**France**  
01 30 09 21 10  
01 30 09 21 11  
[franceinfo@phenomenex.com](mailto:franceinfo@phenomenex.com)

**United Kingdom**  
01625-501367  
01625-501796  
[ukinfo@phenomenex.com](mailto:ukinfo@phenomenex.com)

**Ireland**  
01 247 5405  
+44 1625-501796  
[eireinfo@phenomenex.com](mailto:eireinfo@phenomenex.com)

**Germany**  
06021-58830-0  
06021-58830-11  
[anfrage@phenomenex.com](mailto:anfrage@phenomenex.com)

**New Zealand**  
09-4780951  
09-4780952  
[info@phenomenex.co.nz](mailto:info@phenomenex.co.nz)

**Australia**  
02-9428-6444  
02-9428-6445  
[info@phenomenex.com.au](mailto:info@phenomenex.com.au)

## Materials and Methods

Analyses were performed using an HP 1100 LC system (Agilent Technologies, Palo Alto, CA, USA) equipped with a binary pump, UV detector, and using HP Chemstation software for data analysis. The mass spectrometer used was an Applied Biosystems API 3000 equipped with a Turboionspray ESI source. SPE Tubes for sample cleanup were strata-X tubes (30 mg/1 mL) (Phenomenex, Torrance, CA, USA). The HPLC column used for the analyses was Gemini 5µm C18 150 x 3.0 mm (Phenomenex, Torrance, CA, USA). Steroid standards and formic acid were purchased from Sigma Chemicals (St. Louis, MO, USA). Solvents were purchased from Fisher Scientific (Fairlawn, NJ, USA). Human plasma was purchased from SeraCare Life Sciences, Inc (Oceanside, CA, USA). Human urine was collected from healthy adults.

**Table 1. SPE Method using strata-X**

<b>CONDITION</b>
1 mL Methanol followed by 1mL water
<b>LOAD</b>
1 mL spiked human serum or urine (diluted 1:1 with water)
<b>WASH</b>
1 mL water followed by 1 mL 40% methanol in water
<b>ELUTE</b>
1mL methanol
<b>EVAPORATE AND RECONSTITUTE</b>
under nitrogen stream (ambient)
100 µL acetonitrile/water 40:60

For all separations an aliquot of 100 µL of steroid standard at different levels (from 500 ng/mL to 8 ng/mL) is spiked into either plasma or urine samples. Urine or plasma samples are diluted 1:1 with water prior to loading on SPE cartridge

## SPE Sample Preparation

Sample cleanup is described in table 1. In short, the SPE cartridge is conditioned with methanol and water, and then diluted plasma or urine sample is loaded on. The cartridge is then washed with diluted methanol and then eluted with 100% methanol. Sample is evaporated with nitrogen and reconstituted in acetonitrile/water before injection on HPLC column.

## HPLC Methodology

A 150 x 3.0 mm Gemini 5µm C18 column was used for efficient separation of steroids as well as reduced solvent usage. Mobile phase A was 0.1% formic acid in water and mobile phase B was 0.1% formic acid in 95% acetonitrile/ water. Gradient elution was performed with a gradient after holding at initial conditions of 40% B for 4 minutes. At 4 minutes, a gradient from 40% B to 75% B is performed over 11 minutes. Column is then re-equilibrated at 40% B for 5 minutes prior to subsequent injections. Flow rate is 0.6 mL/min at ambient conditions and detection for LC-UV runs is monitored at 254 nm.

## MS Detection

For improved sensitivity and accuracy in quantitation, MS detection with the API 3000 is also used. An electrospray interface is operated in positive ion mode with 6500 cc/min heater gas flow heated to 450°C. MS/MS Detection using multiple reaction monitoring (MRM) of specific daughter ions was used for quantitation of each individual analyte.

**Figure 3. Calibration Curves**

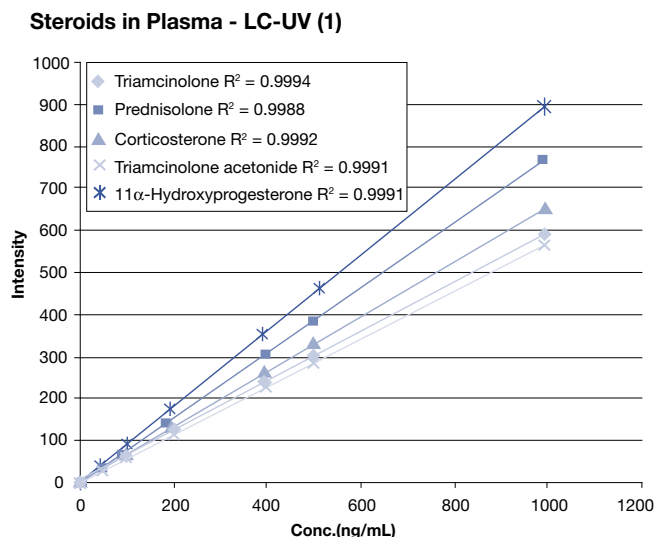

**Figure 3:** HPLC-UV Response curve for several steroids. As shown, the response curve for most steroids is linear from 50 ng/mL to 1000 ng/mL range.

## Results

Structures of several key corticosteroids are listed in figure 1. Most steroids are very similar in structure as well as molecular weight; thus, the need for a HPLC column that can baseline resolve steroids is critical for accurate quantitation by HPLC-UV. A chromatogram of a 500 ng/mL initial concentration (5 µg/mL after SPE) standard of 10 major steroids is shown in figure 2. All of the major steroids are baseline separated by the Gemini C18 column with a cycle time of 20 minutes.

While standards can be directly analyzed on HPLC without any difficulty, interferences due to proteins, lipids, and salts require cleanup by SPE prior to injection for plasma and urine samples. A simple protocol using strata-X for sample cleanup is shown in table 1. SPE using strata-X removes most matrix contaminants from the sample that would interfere with UV and MS detection, as well as allows for concentration of dilute samples.

Because the Gemini C18 column baseline separates most steroids, detection by UV allows for detection of most major corticosteroids down to levels around 50 ng/mL with good linearity  $r^2 > 0.995$  and accuracy (98-105%). The calibration curve for several steroids is shown in figure 3.

**Figure 4. LC/MS/MS Chromatogram of Steroid Standard in Urine**

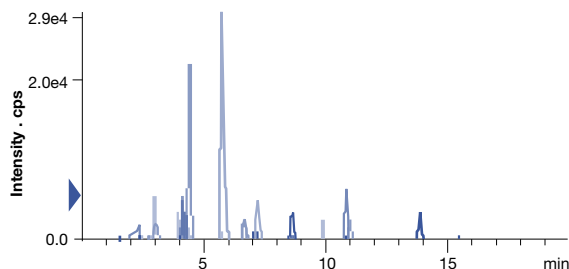

**Figure 4:** Extracted ion chromatogram overlay of MRM transitions for 13 different steroids spiked in urine. Spiked concentration of urine is 8 ng/mL.

**Figure 5. LC/MS/MS Chromatogram of a Blank Urine Sample**

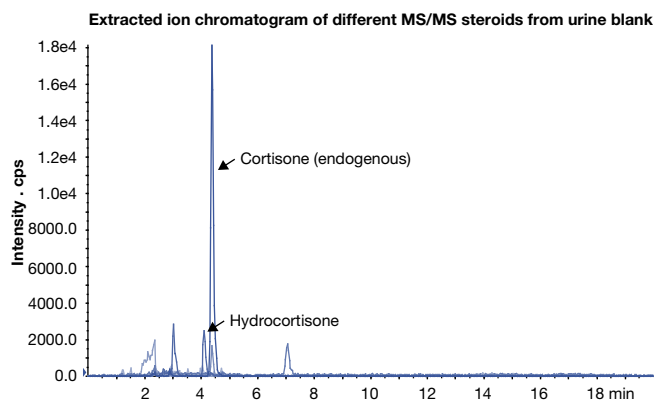

**Figure 5:** Extracted ion chromatogram overlay for the same 13 different steroids as figure 4 in a blank urine sample. Note the large Hydrocortisone and Cortisone peaks as representative endogenous steroids.

While UV detection may be sensitive enough to detect current steroid usage and monitor steroid levels for therapeutic treatments, detection of past steroid usage may require the more sensitive detection offered by a tandem mass spectrometer.

A chromatogram of a very low level (8µg/mL) spiked urine sample is shown in figure 4. Such low level detection allows for identification of past steroid usage. Indeed, the sensitivity of using MS/MS detection allows quantification of background endogenous steroids (cortisone and hydrocortisone) found in blank urine (figure 5). With MS detection, such low level endogenous amounts must be taken into account with any testing method for illicit steroid use. Linear quantification data using MS detection with Gemini C18 HPLC columns and strata-X SPE cartridges is shown in figure 6. As one can see, MS/MS detection with the Gemini column and strata-X SPE cartridges delivers excellent linearity and reproducibility for such methods, and are powerful tools for quantitation of steroid levels in plasma and urine. We found the reproducibility very good (data not shown).

**Figure 6. Calibration Curves for LC/MS/MS for 12 Common Steroids**

**Steroids in Urine - Standard Calibration Curves LC\MS\MS (1)**

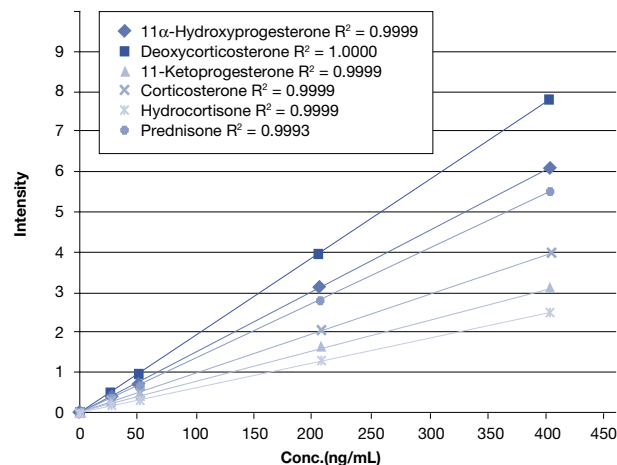

**Steroids in Urine - Standard Calibration Curves LC\MS\MS (2)**

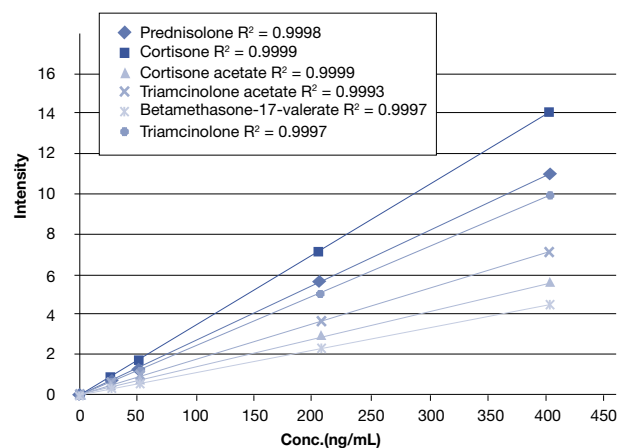

**Figure 6A and 6B:** Response curves for 12 different steroids by LC/MS/MS. Note the excellent linearity for all steroids shown.

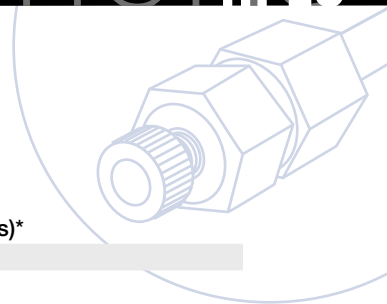

## Conclusions

Gemini C18 is an excellent solution for obtaining baseline separation of key steroids, which is a prerequisite of proper quantitation of HPLC-UV.

SPE using strata-X allows for rapid cleanup of steroids from urine and plasma samples. The quantitative and reproducible recovery of steroids provides an accurate determination of steroid levels in complex sample matrices.

The method described allows for detection by either UV or MS depending on the sensitivity required for the application. The excellent cleanup provided by the strata-X SPE cartridges along with virtually no column bleed for the Gemini C18 column allows for highly accurate low level detection of steroids.

## References

1. Oneeb Majid, Fatemeh Akhlaghi et. al. "Simultaneous Determination of Plasma Prednisolone, Prednisone, and Cortisol Levels by High-Performance Liquid Chromatography" Therapeutic Drug Monitoring 23:163-168 2001
2. S. AbuRuz, J. Millership, L. Heaney et. al. "Simple liquid chromatography method for the rapid simultaneous determination of prednisolone and cortisol in plasma and urine using hydrophilic lipophilic balanced solid phase extraction Cartridges" J. of Chromatography B. 798 (2003) 193-201
3. Susan S. C. Tai and Michael J. Welch "Development and Evaluation of a Candidate Reference Method for the Determination of Total Cortisol in Human Serum..." Anal. Chem. 2004,76,1008-1014
4. Robert L. Taylor, Dwaine Machacek, et. al. "Validation of a High-Throughput Liquid Chromatography – Tandem Mass Spectrometry Method for Urinary Cortisol and Cortisone" Clin.Chem.2002 48:9 1511-1519
5. Song-Ja Park, Yun-Je Kim et. al. "Analysis of Corticosteroids in Urine by HPLC and Thermospray LC/MS" Journal of Anal. Toxicolog. Vol. 14 March/April 1990

## Ordering Information

### Gemini™ 3µm C18 (selected dimensions)\*

Order No.	Dimension
00B-4439-B0-TN	50 x 2.0mm
00B-4439-E0-TN	50 x 4.6mm
00F-4439-B0-TN	150 x 2.0mm
00F-4439-E0-TN	150 x 4.6mm

### Gemini™ 5µm C18 (selected dimensions)\*

Order No.	Dimension
00B-4435-B0-TN	50 x 2.0mm
00B-4435-E0-TN	150 x 3.0mm
00F-4435-B0-TN	150 x 4.6mm
00F-4435-E0-TN	250 x 4.6mm

### strata™X Tubes (selected dimensions)\*

Order No.	Description
8B-S100-TAK-TN	3mg/1mL
8B-S100-UBJ-TN	60mg/3mL
8B-S100-HBJ-TN	500mg/3mL
8B-S100-HCH-TN	500mg/6mL
00M-S033-B0-CB	25mm On-Line Extraction Cartridge 20 x 2.0mm

\* Other dimensions and particle sizes available, please contact your Phenomenex representative for more information.



[www.phenomenex.com](http://www.phenomenex.com)

Phenomenex products are available worldwide. For the distributor in your country, contact Phenomenex USA, International Department by telephone, fax or e-mail: [international@phenomenex.com](mailto:international@phenomenex.com).

	<b>USA</b>	<b>Puerto Rico</b>	<b>Canada</b>	<b>France</b>	<b>United Kingdom</b>	<b>Ireland</b>	<b>Germany</b>	<b>New Zealand</b>	<b>Australia</b>
tel.:	(310) 212-0555	(800) 541-HPLC	(800) 543-3681	01 30 09 21 10	01625-501367	01 247 5405	06021-58830-0	09-4780951	02-9428-6444
fax:	(310) 328-7768	(310) 328-7768	(310) 328-7768	01 30 09 21 11	01625-501796	+44 1625-501796	06021-58830-11	09-4780952	02-9428-6445
email:	<a href="mailto:info@phenomenex.com">info@phenomenex.com</a>	<a href="mailto:info@phenomenex.com">info@phenomenex.com</a>	<a href="mailto:info@phenomenex.com">info@phenomenex.com</a>	<a href="mailto:franceinfo@phenomenex.com">franceinfo@phenomenex.com</a>	<a href="mailto:ukinfo@phenomenex.com">ukinfo@phenomenex.com</a>	<a href="mailto:eireinfo@phenomenex.com">eireinfo@phenomenex.com</a>	<a href="mailto:anfrage@phenomenex.com">anfrage@phenomenex.com</a>	<a href="mailto:info@phenomenex.co.nz">info@phenomenex.co.nz</a>	<a href="mailto:info@phenomenex.com.au">info@phenomenex.com.au</a>