

UHPLC Column and System Protection Essentials



Vials



Filters



Syringe Filters



Fittings



Guards

Maximize system performance and uptime while reducing troubleshooting downtime

guarantee

If you are not completely satisfied with any of the products featured in this brochure, return the product within 45 days for a FULL REFUND

Now that you've made the investment in UHPLC, you'll need to protect your instrument and columns to enable them to deliver optimal performance.



UHPLC Equipment Needs:

▶ High quality vials and caps

- Reduces contaminants and septa bleed
- Offer cleaner samples and fewer interfering ghost peaks

▶ UHPLC guard columns

- Removes unwanted shedding of injector parts, pump seals, and particulates
- Extend column lifetime
- Reduce potential for unscheduled system downtime and costly repairs

▶ Filtered samples and mobile phases

- Removes damaging particulates

FILTERED Samples Can Help You...

- Increase Column Lifetime
- Improve Analytical Results
- Decrease System Downtime and Costly Repairs

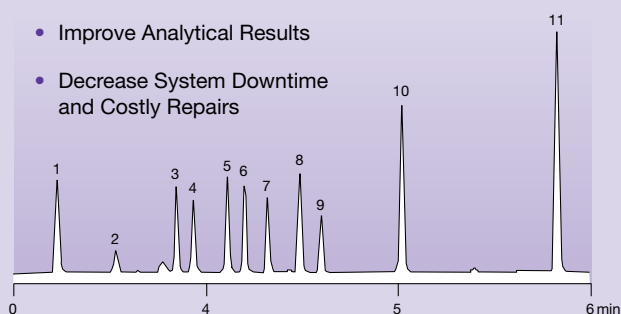

NON-FILTERED Samples Can Cause...

- Baseline Noise, Ghost and Split Peaks
- High Operating Pressures
- Damage to Detectors, Pumps, and Valves

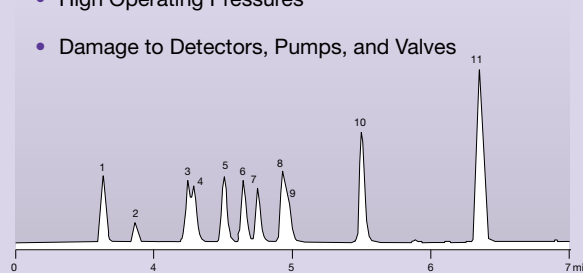

© 2014 Phenomenex Inc. All rights reserved.

Phenomenex

USA Tel: 310-212-0555 | Canada Tel: 800-543-3681 | Puerto Rico Tel: 800-541-4752
Fax: 310-328-7768 Email: info@phenomenex.com Web: www.phenomenex.com

Choose from our extensive offering of quality UHPLC accessories designed to meet your application needs.

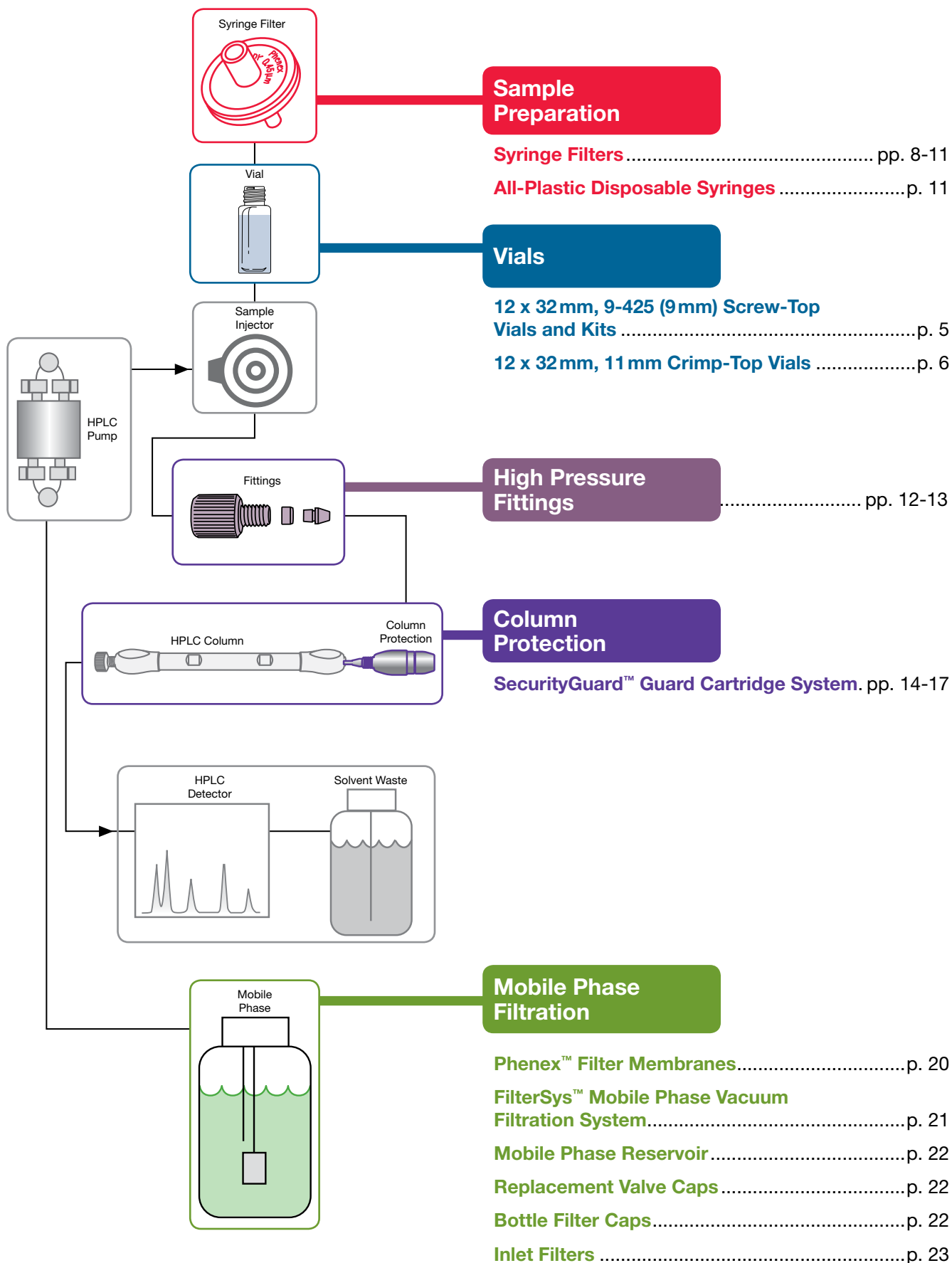

Certified Vial Products Redefined

Though they may look alike, not all vials offer equivalent performance. Variations in product quality can adversely affect your UHPLC chromatography, leading to mystery peaks, loss

of analytes, and irreproducible results. Begin every analysis with high quality Verex™ products to minimize troubleshooting delays, and costly, unnecessary rework.

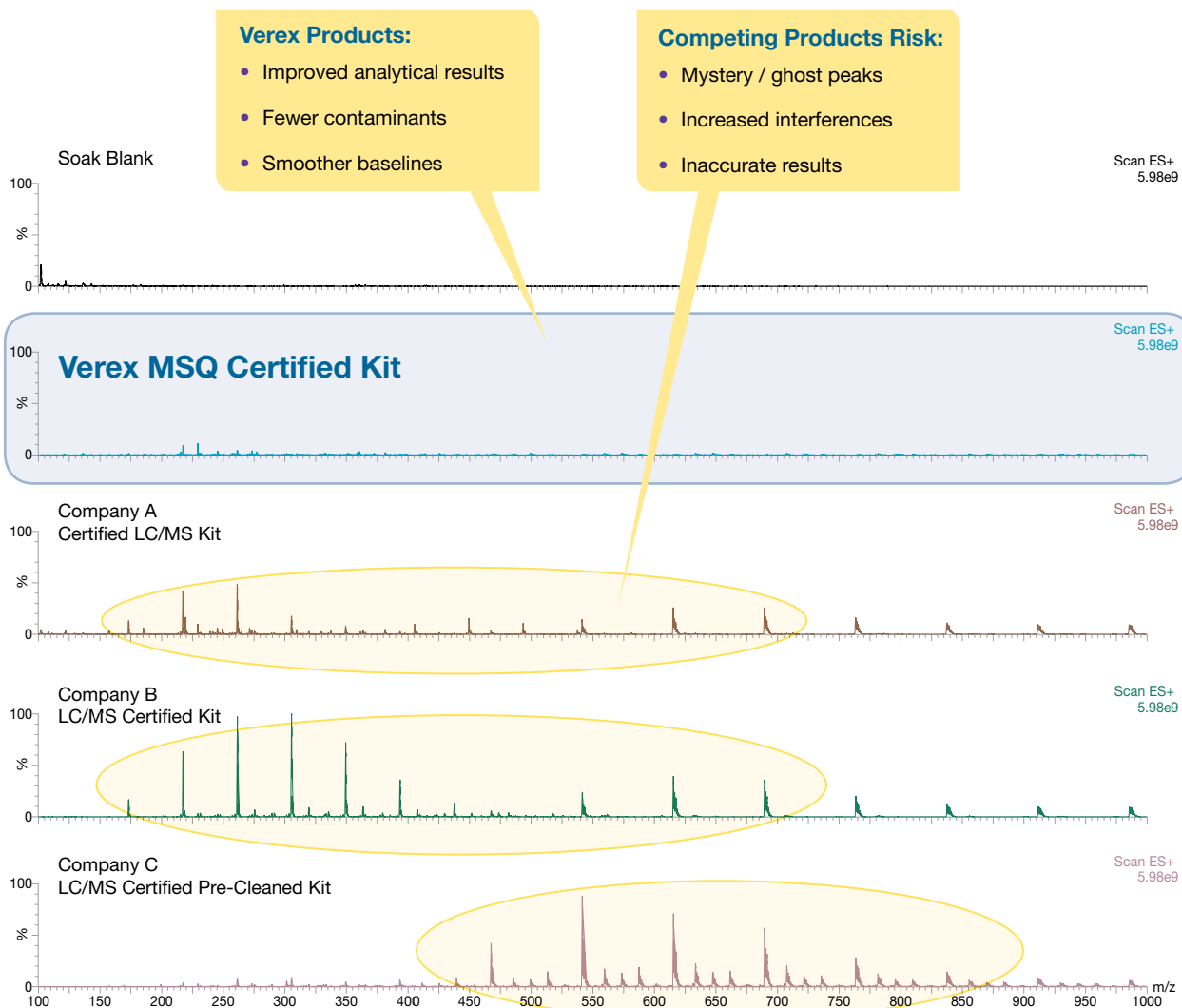

To minimize the potential for ghost peaks and interferences, we recommend the use of Verex MSQ Certified vials and caps. These products deliver unmatched performance (as seen in the comparison above). Other companies' LC/MS certified products can contaminate your sample and introduce unidentifiable mystery peaks.

12 x 32 mm, 9-425 (9 mm) Screw-Top Vials and Kits

Convenience Kits – Certified PLUS (Cert+) Mass Spec Quality (MSQ) 9-425 Screw-Top Vials and Caps with Locked-Fit Septa

- For your most demanding analysis; high sensitive detectors
- HPLC and LC/MS tested and certified
- State-of-the-art design and manufacture

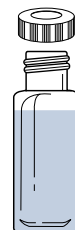

Ordering Information†

Description	1000/pk	Price
Cert+ MSQ Vial Kit, 9 mm, 2 mL Clear w/ Patch + MSQ PTFE/Silicone	ARO-992A-13-M	\$ 595
Cert+ MSQ Vial Kit, 9 mm, 2 mL Amber w/ Patch + MSQ PTFE/Silicone	ARO-992B-13-M	635

†Certified PLUS (Cert+) Level 3 Certification

Convenience Kits – Limited Volume Specialty 9-425 Screw-Top Vials and Caps with Bonded-In Septa

- Kits for microsampling (center-draining and fused-insert vials)
- CD and Qsert vials offer superior performance over vials with loose inserts
- Polypropylene (PP) vial kits for bio- or ion-chromatography, or pH-sensitive samples

Ordering Information

Description	100/pk	Price	1000/pk	Price
Vial Kit, 9 mm, High Recovery (CD) Clear + PTFE/Silicone	ARO-9981-12	\$ 179	ARO-9981-13	\$ 1,439
Vial Kit, 9 mm, High Recovery (CD) Clear + PTFE/Silicone, preSlit	ARO-9982-12	189	ARO-9982-13	1,505
Vial Kit, 9 mm, µVial i3 (Qsert) Clear w/ Patch + PTFE/Silicone	ARO-9973-12	179	ARO-9973-13	1,465
Vial Kit, 9 mm, µVial i3 (Qsert) Clear w/ Patch + PTFE/Silicone, preSlit	ARO-9974-12	189	ARO-9974-13	1,555
Vial Kit, 9 mm, PP, 300 µL + PTFE/Silicone*	ARO-9991-12	60	ARO-9991-13	419
Vial Kit, 9 mm, PP, 300 µL + PTFE/Silicone, preSlit*	ARO-9992-12	189	ARO-9992-13	465

No write-on patch unless otherwise indicated.

*Made of Polypropylene

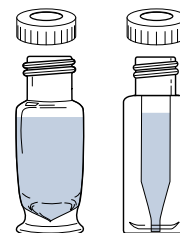

9-425 Screw-Top Vials, 2.0 mL

- Used with most autosamplers, including Agilent®, Thermo Scientific®, Waters®, and many others
- Performs as well as crimp or snap vials
- Offers improved cap convenience and accessibility (easy on, easy off)

Ordering Information

Description	1000/pk	Price
Vial, 9mm Screw, 2 mL Clear, No Patch	ARO-3900-13	\$ 189
Vial, 9mm Screw, 2 mL Amber, No Patch	ARO-3901-13	199
Vial, 9mm Screw, 2 mL Clear, w/ Patch	ARO-3910-13	199
Vial, 9mm Screw, 2 mL Amber, w/ Patch	ARO-3911-13	209
Vial, 9mm Screw, 2 mL Clear, w/ Patch, Silanized	ARO-3960-13	509

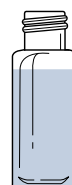

Limited Volume Specialty 9-425 Screw-Top Vials

- Microsampling Qsert and v-Vial center-draining vials
- Qsert fused-insert vials ensure proper seating of the cap
- Extremely low residual volume

Ordering Information

Description	100/pk	Price	1000/pk	Price
Vial, 9 mm Screw, µVial i3 (Qsert) Clear, No Patch	ARO-3920-12	\$ 145	ARO-3920-13	\$ 1,119
Vial, 9 mm Screw, µVial i3 (Qsert) Amber, No Patch	ARO-3921-12	155	ARO-3921-13	1,219
Vial, 9 mm Screw, v-Vial Clear, No Patch**	ARO-3940-12	145	ARO-3940-13	1,119
Vial, 9 mm Screw, v-Vial Amber, No Patch**	ARO-3941-12	155	ARO-3941-13	1,219
Cert+ Vial, 9 mm Screw, PP, 300 µL Clear, No Patch*	ARO-39S0-12-C	30	ARO-39S0-13-C	229

**51-Expansion glass.

*Made of Polypropylene.

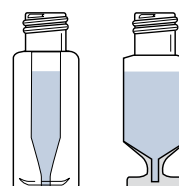

12 x 32 mm, 11 mm Crimp-Top Vial and Seals/Closures

Crimp-Top Vials, 2.0 mL

- Cleaner vials eliminate ghost peaks and contaminants
- Used with most autosamplers, including Agilent®, Thermo Scientific®, Waters®
- Larger-opening “wide-mouth” style prevents broken needles and system downtime
- Precision neck improves crimping

Ordering Information

Description	1000/pk	Price
Standard Opening		
Vial, Crimp, 2 mL Clear, No Patch	ARO-3700-13	\$ 179
Vial, Crimp, 2 mL Clear, w/ Patch	ARO-3710-13	189
Vial, Crimp, 2 mL Amber, w/ Patch	ARO-3711-13	199
Wide Mouth Opening		
Vial, Crimp, 2 mL Wide Mouth, Clear, No Patch	ARO-37K0-13	\$ 185
Vial, Crimp, 2 mL Wide Mouth, Clear, w/ Patch	ARO-37L0-13	195
Vial, Crimp, 2 mL Wide Mouth, Amber, No Patch	ARO-37K1-13	195
Vial, Crimp, 2 mL Wide Mouth, Amber, w/ Patch	ARO-37L1-13	205

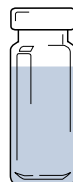

Limited Volume Specialty Crimp-Top Vials

- Microsampling (center-draining and fused-insert vials)

Ordering Information

Description	100/pk	Price	1000/pk	Price
Vial, Crimp, v-Vial Clear, No Patch*	—	—	ARO-3740-13	\$ 1,119
Vial, Crimp, v-Vial Amber, No Patch*	—	—	ARO-3741-13	1,219
Vial, Crimp, µVial i3 (Qsert), Clear, w/ Patch	ARO-3725-12	\$ 165	ARO-3725-13	1,219
Vial, Crimp, µVial i3 (Qsert), Amber, w/ Patch	ARO-3726-12	175	ARO-3726-13	1,319

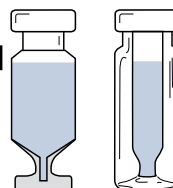

*51-Expansion glass.

Seals / Closures for Crimp-Top Vials

- Excellent for volatile samples
- Extra clean to eliminate contamination
- Colored aluminum

Ordering Information

Description	1000/pk	Price
Seal, 11 mm Diameter, Crimp, PTFE/Silicone, silver	ARO-5780-13	\$ 275
Seal, 11 mm Diameter, Crimp, PTFE/Silicone/PTFE, silver	ARO-5760-13	285
Seal, 11 mm Diameter, Crimp, PTFE/Rubber, silver	ARO-5740-13	165
Seal, 11 mm Diameter, Crimp, PTFE/Rubber, blue	ARO-5742-13	175
Seal, 11 mm Diameter, Crimp, PTFE/Rubber, red	ARO-5741-13	175
Seal, 11 mm Diameter, Crimp, PTFE/Rubber, green	ARO-5743-13	175
Seal, 11 mm Diameter, Crimp, PTFE/Rubber, gold	ARO-574G-13	175
Seal, 11 mm Diameter, Crimp, PTFE, silver	ARO-5710-13	185



For additional vial product selection and detailed information visit:

www.phenomenex.com/Verex

Make the Switch to Verex!

Finding the Verex replacement to your current vials and caps is EASY.



Use our online web tool to find the guaranteed Verex product match.

www.Phenomenex.com/VialMatch

2 Easy Steps:

1. Enter your current vial or cap part number
2. Order the recommended Verex part number

The screenshot shows the Phenomenex website interface. At the top, there's a navigation bar with 'Log in', 'Sign Up', and 'English'. Below that is a search bar and a 'Search Options' dropdown. The main content area is titled 'Search' and has several tabs: 'Site Search', 'Alternative Search Options', 'HPLC', 'GC', 'Sample Prep', 'Accessories', and 'Applications'. The 'Accessories' tab is selected, and the 'Vials' sub-tab is active. A search bar on the left is highlighted with a red box and a blue arrow labeled '1'. Below the search bar, there are filters for 'Type', 'Vial Size', 'Vial Closure', 'Vial Material', 'Certification', and 'Cap Size'. The main content area shows 'Selected Part' information for a Verex vial, including 'Part Number: 880-3000-12', 'Description: Verex™ Vial, 10mm Screw Top, 3ml, Clear 32, No Patch, 100%', and 'Certification: Certified'. Below this, there are '432 Search Results' and a table with columns for 'Part Number', 'Description', and 'Price'. The first row in the table is highlighted with a red box and a blue arrow labeled '2'.

Part Number	Description	Price
880-3000-12	Verex™ Vial, 10mm Screw Top, 3ml, Clear 32, No Patch, 100%	(100/TK)
880-3000-13	Verex™ Vial, 10mm Screw Top, 3ml, Clear 32, No Patch, 100%	(100/TK)





Sample Preparation for UHPLC

Eliminate damaging contaminants and undesirable components before they reach your expensive UHPLC system and column!

Why is UHPLC sample preparation important?

Sample preparation products protect your UHPLC column and system from particulates and contaminants, which lead to shorter column lifetime, increased unscheduled UHPLC system downtime, and unacceptable results.

- Filtering your samples reduces the risk of contamination and clogging of your UHPLC column and system components.
- Clean samples extend UHPLC column lifetimes and decrease the incidence of high pressure fluctuations caused by particulate and contaminant buildup at the head of the column.
- Effective sample filtration also saves your UHPLC system's rotor seals, and valve stators from unnecessary wear and damage caused by undissolved sample particulates grinding away at the expensive injection port components.

Filtration Cleans Sample Prior to Analysis



Need assistance selecting the best syringe filter for your application?

Use our online web tool to find the guaranteed match. Visit:

www.phenomenex.com/SFMatch



How does UHPLC sample preparation work?

- Phenex syringe filters utilize a filter membrane to remove particulates from your sample, and thus prevent particulates from entering the injector and the UHPLC column. Samples are easily pushed through the 0.20 μm filter membrane (recommended for UHPLC samples) with a syringe and then the collected filtered samples are ready for UHPLC analysis.
- Columns packed with $\leq 3 \mu\text{m}$ chromatographic media require a syringe filter with 0.20 μm filter membrane to ensure complete removal of unwanted particulates from entering the system flow path. The benefits are longer column lifetimes and increased system uptime while also protecting your UHPLC system from over-pressurization. Spurious and split peak phenomena are reduced, enhancing overall chromatographic reliability and reproducibility.
- UHPLC systems utilize relatively small internal diameter connection tubing ($\leq 0.005''$ or $\leq 0.127 \text{ mm}$) compared with traditional HPLC systems in order to minimize system dead volume contributions. Removing particulates is essential to reducing the potential for clogged tubing and maintaining system backpressures as low as possible to reduce system wear and tear.

UHPLC Column Flow Path

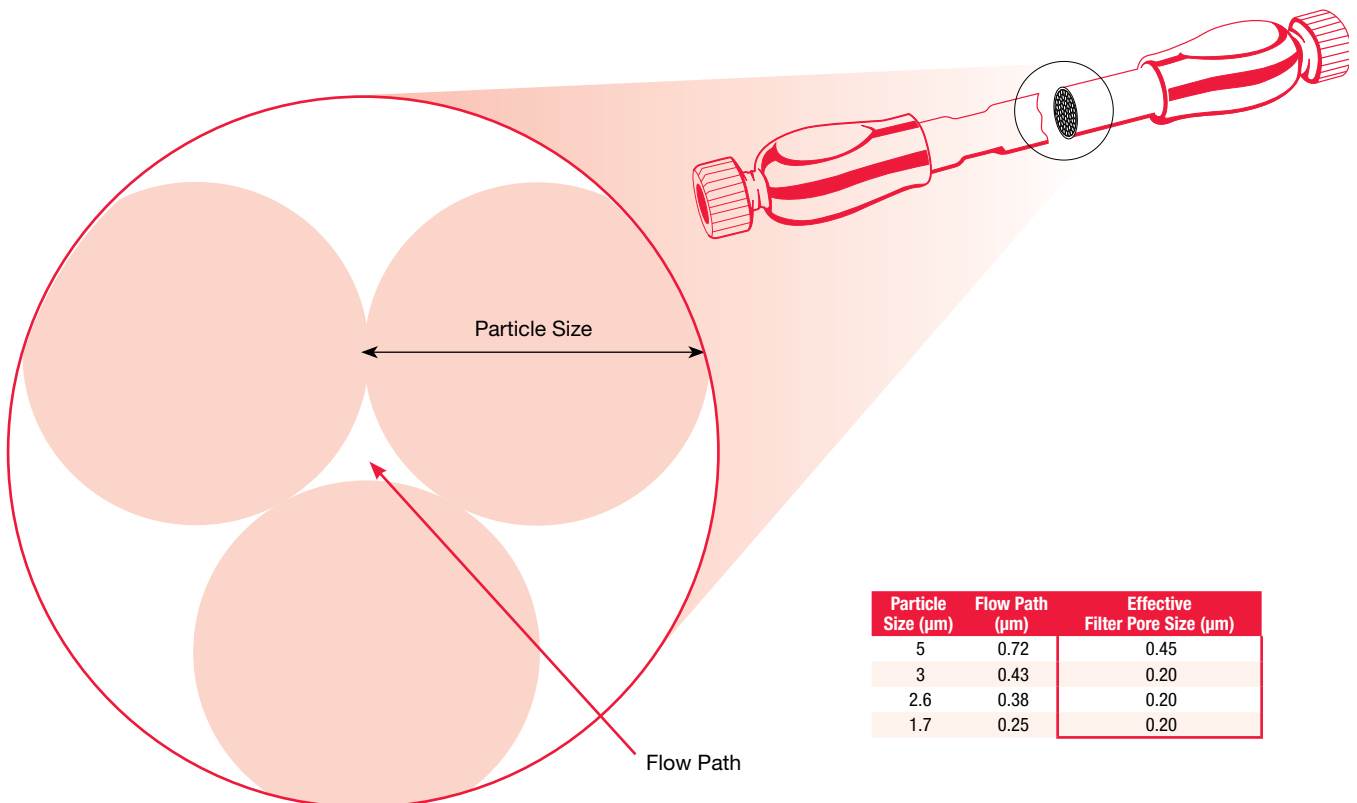



UHPLC Sample Preparation



Protect injector valves, prevent costly rework, and reduce system downtime



Phenex syringe filters increase column lifetime and improve chromatographic reproducibility. Phenex offers a variety of chemically compatible syringe filter membranes that are ideal for any application. Proper membrane and size selection are the keys to choosing the best product matched to your sample while protecting your UHPLC, HPLC, or GC column system from particulate contamination.





Select your filter in three EASY steps:

1. Select filter diameter based on sample volume

If your sample volume is:

≤ 2 mL Sample Volume	2 to 10 mL Sample Volume	10 to 100 mL Sample Volume
4 mm Diameter 	15 mm Diameter 	25 - 28 mm Diameter 

2. Select pore size based on the nature of your sample and chromatographic method

Sample Description	Recommended Filter Pore Size
General aqueous or mixed organic samples prior to HPLC analysis with column packed with > 3 μm particles. General clarification of GC, SFC, CE, and GPC samples.	0.45 μm 
Viscous samples or samples containing high levels of particulate matter.	
General aqueous or mixed organic samples prior to HPLC analysis with columns packed with ≤ 3 μm particles. Removal of fine particulate matter prior to GC, SFC, CE, and GPC samples.	0.20 μm 
Liquid samples prior to UHPLC or LC/MS. Other particulate-sensitive methods.	
Viscous samples such as serum, plasma, or other biological matrices. Solutions with high particulate load (e.g., some environmental or food and beverage applications).	Glass Fiber Filter with 0.45 μm filter membrane

3. Select filter membrane according to the characteristics of your sample and filtering objective



Aqueous

Sample Characteristic	Membrane Type
Solvent Mixtures	RC (Regenerated Cellulose)
Tissue Culture Media, Buffers	CA (Cellulose Acetate)
Protein Analysis /Biological Samples	PES or PVDF (Polyethersulfone or Polyvinylidene Fluoride)

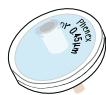

Solvents

Sample Characteristic	Membrane Type
Non-Aqueous / Hydrophobic	PTFE (Polytetrafluoroethylene)
Aqueous Mixtures / Hydrophilic	RC or PVDF (Regenerated Cellulose or Polyvinylidene Fluoride)

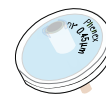

Particulate-laden samples may require pre-filtration



UHPLC Sample Preparation

Phenex Syringe Filters

Ordering Information

Membrane Type/Size	4 mm Diameter for ≤ 2 mL sample volumes			15 mm Diameter for 2 – 10 mL sample volumes			25–28 mm Diameter for 10 – 100 mL sample volumes		
	Part No.	Unit	Price	Part No.	Unit	Price	Part No.	Unit	Price
0.20 µm									
Phenex-RC (Regenerated Cellulose)	AF0-3203-12	100/pk	\$ 165	AF0-2203-12	100/pk	\$ 179	AF0-8203-12 ⁵	100/pk	\$ 219
	AF0-3203-52	500/pk	595	AF0-2203-52	500/pk	679	AF0-8203-52 ⁵	500/pk	845
Phenex-PES ³ (Polyethersulfone)	—	—	—	—	—	—	AF0-8208-12 ⁷	100/pk	239
	—	—	—	—	—	—	AF0-8208-52 ⁷	500/pk	935
Phenex-PTFE ⁶ (Polytetrafluoroethylene)	AF0-3202-12	100/pk	169	AF0-2202-12	100/pk	205	AF0-1202-12	100/pk	239
	AF0-3202-52	500/pk	639	AF0-2202-52	500/pk	785	AF0-1202-52	500/pk	935
Phenex-NY (Nylon)	AF3-3207-12	100/pk	169	AF0-2207-12	100/pk	179	AF0-1207-12	100/pk	235
	AF3-3207-52	500/pk	635	AF0-2207-52	500/pk	679	AF0-1207-52	500/pk	895
Phenex-GF/NY (Glass Fiber/Nylon)	An integrated syringe filter unit containing an inert borosilicate glass fiber prefilter and a Nylon (NY) membrane. Excellent for filtration of particle-laden samples, such as foods and beverages, environmental, biofuels, and dissolution samples. Use less hand pressure to filter even the most difficult samples. Outlet connection is luer lock.						AF0-1A47-12 ⁷	100/pk	375
Phenex-PVDF (Polyvinylidene Fluoride)	—	—	—	AF6-5206-12	100/pk	\$ 185	AF6-6206-12	100/pk	236
	—	—	—	AF6-5206-52	500/pk	669	AF6-6206-52	500/pk	899
Phenex-GF/PVDF (Glass Fiber/Polyvinylidene Fluoride)	An integrated syringe filter unit containing an inert borosilicate glass fiber prefilter and a PVDF membrane. The hydrophilic PVDF membrane provides high flow rates and throughput, low extractables and broad chemical compatibility. This membrane binds less protein than nylon or PTFE membranes.						AF6-6C06-12	100/pk	359
Phenex-CA ⁴ (Cellulose Acetate)	—	—	—	—	—	—	AF0-8204-12 ⁷	100/pk	205
	—	—	—	—	—	—	AF0-8204-52 ⁷	500/pk	789
Phenex-GF/CA ^{2,3,4} (Glass Fiber/Cellulose Acetate)	An integrated syringe filter unit containing an inert borosilicate glass fiber prefilter and a CA membrane. Excellent for filtration of tissue culture media, general biological sample filtration and clarification. Outlet connection is luer lock.						AF0-8A09-12 ⁷	100/pk	269
							AF0-8A09-52 ⁷	500/pk	1,055
0.45 µm									
Phenex-RC (Regenerated Cellulose)	AF0-3103-12	100/pk	\$ 165	AF0-2103-12	100/pk	\$ 179	AF0-8103-12 ⁵	100/pk	\$ 219
	AF0-3103-52	500/pk	595	AF0-2103-52	500/pk	679	AF0-8103-52 ⁵	500/pk	845
Phenex-PES ³ (Polyethersulfone)	—	—	—	—	—	—	AF0-8108-12 ⁷	100/pk	239
	—	—	—	—	—	—	AF0-8108-52 ⁷	500/pk	935
Phenex-PTFE ⁶ (Polytetrafluoroethylene)	AF0-3102-12	100/pk	169	AF0-2102-12	100/pk	205	AF0-1102-12	100/pk	239
	AF0-3102-52	500/pk	639	AF0-2102-52	500/pk	785	AF0-1102-52	500/pk	935
Phenex-NY (Nylon)	AF3-3107-12	100/pk	169	AF0-2107-12	100/pk	185	AF0-1107-12	100/pk	235
	AF3-3107-52	500/pk	635	AF0-2107-52	500/pk	705	AF0-1107-52	500/pk	895
Phenex-GF/NY (Glass Fiber/Nylon)	An integrated syringe filter unit containing an inert borosilicate glass fiber prefilter and a Nylon (NY) membrane. Excellent for filtration of particle-laden samples, such as foods and beverages, environmental, biofuels, and dissolution samples. Use less hand pressure to filter even the most difficult samples. Outlet connection is luer lock.						AF0-1B47-12 ⁷	100/pk	375
Phenex-PVDF (Polyvinylidene Fluoride)	—	—	—	AF6-5106-12	100/pk	\$ 175	AF6-6106-12	100/pk	236
	—	—	—	AF6-5106-52	500/pk	669	AF6-6106-52	500/pk	899
Phenex-GF/PVDF (Glass Fiber/Polyvinylidene Fluoride)	An integrated syringe filter unit containing an inert borosilicate glass fiber prefilter and a PVDF membrane. The hydrophilic PVDF membrane provides high flow rates and throughput, low extractables and broad chemical compatibility. This membrane binds less protein than nylon or PTFE membranes.						AF6-6D06-12	100/pk	359
Phenex-GF/CA ^{2,3,4} (Glass Fiber/Cellulose Acetate)	An integrated syringe filter unit containing an inert borosilicate glass fiber prefilter and a CA membrane. Excellent for filtration of tissue culture media, general biological sample filtration and clarification. Outlet connection is luer lock.						AF0-8B09-12 ⁷	100/pk	269
							AF0-8B09-52 ⁷	500/pk	1,055
1.20 µm									
Phenex-GF ^{2,3} (Glass Fiber)	Prefiltration of heavily contaminated or highly viscous samples. When used in-line preceding a membrane filter, clogging of the membrane filter is prevented and sample clean up is optimized. Outlet connection is luer lock.						AF0-8515-12 ⁷	100/pk	\$ 175
							AF0-8515-52 ⁷	500/pk	659

Above syringe filters are non-sterile. Housing is made of medical-grade polypropylene (PP). Luer lock inlet/slip outlet connections unless otherwise indicated.

- Larger quantity purchases at significant savings are available.
- Glass fiber filters are 28 mm diameter and made of borosilicate. They will remove 90 % of all particles > 1.2 µm.
- Housing material is methacrylate butadiene styrene (MBS) polymerisate. Also known as Cyrolite®.
- Cellulose acetate is surfactant-free.
- 26 mm diameter.
- Hydrophobic membrane. Can be made hydrophilic by pre-wetting with IPA.
- 28 mm diameter.
- Additional dimensions and membrane types are available, including sterile filters. Please contact your local Phenomenex technical consultant or distributor for availability or assistance.

All-Plastic Disposable Syringes

- Use for all syringe filter applications
- Luer-lock outlet makes connection easy
- Capacities ranging from 3 to 20 mL
- Made of ultra-clean, high-purity plastic



Ordering Information

Part No.	Description	Capacity (mL)	Unit	Price
AS0-8408	Plastic Disposable Syringes, Luer-lock	3	100/pk	\$ 85
AS0-8409	Plastic Disposable Syringes, Luer-lock	5	100/pk	95
AS0-8410	Plastic Disposable Syringes, Luer-lock	10	100/pk	105
AS0-8411	Plastic Disposable Syringes, Luer-lock	20	100/pk	120

* Choose larger volume syringe to reduce force on syringe filter membrane. 10 mL or larger syringe is recommended.



Core-Shell Performance Enhancement Kit

- Optimize UHPLC system connections – for both routine and critical applications
- Increase method efficiency, resolution, and detection
- Minimize dead volume between injector and detector
- Make connections quickly and reliably – every time, on any analytical system
- Improve results for sensitive and demanding applications

The connections made throughout the system are critical to maximizing the benefit from your UHPLC setup. The fittings and tubing used in this kit are carefully chosen to minimize dead volume and reduce band broadening. Combined with a core-shell column and the SecurityGuard™ ULTRA column protection system, the kit will provide reliable connections and quality performance every time.



Installing your core-shell performance enhancement kit

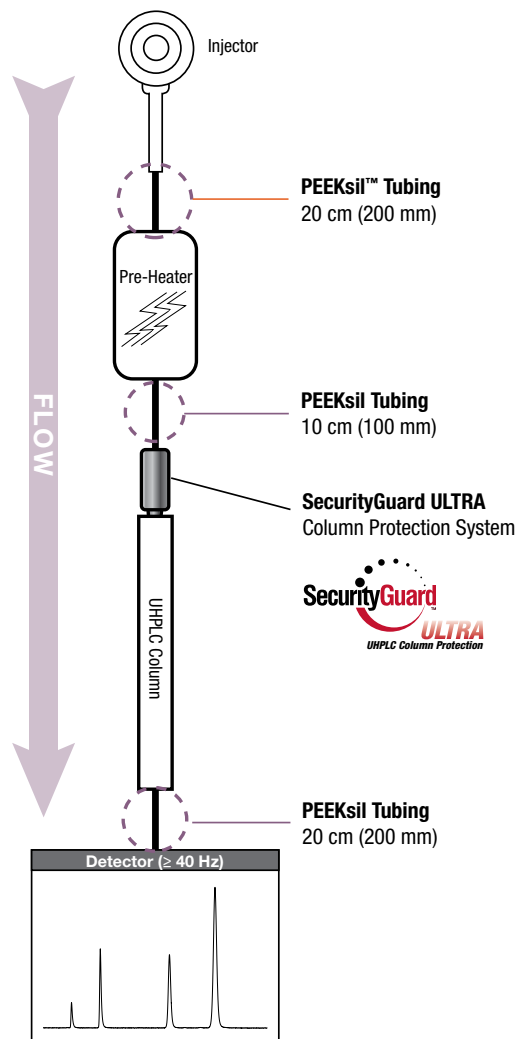

Ordering Information

Core-Shell Performance Enhancement Kit

Part No.	Description	Unit	Price
AQ0-8892	Core-Shell Performance Enhancement Kit, Includes: PEEKsil™ Tubing, Fittings and Tool*	ea	\$ 259

*Kit AQ0-8892 includes the following components:

	Kit Quantity
PEEKsil Tubing 0.100 mm ID x 1/16 in. OD x 20 cm L, Red	2/pk
PEEKsil Tubing 0.100 mm ID x 1/16 in. OD x 10 cm L, Red	ea
Sure-Lok™ High Pressure PEEK 1-Pc Nut, 10-32, for 1/16 in. Tubing	10/pk
Sure-Lok Fitting Tightening Tool, Aluminum	ea

Accessories and Replacement Parts

Part No.	Description	Unit	Price
ATO-8896	PEEKsil Tubing 0.100 mm ID x 1/16 in. OD x 20 cm L, Red	5/pk	\$ 90
ATO-8897	PEEKsil Tubing 0.100 mm ID x 1/16 in. OD x 10 cm L, Red	5/pk	80
AQ0-8503	Sure-Lok High Pressure PEEK 1-Pc Nut, 10-32, for 1/16 in. Tubing	10/pk	189
AQ0-8530	Sure-Lok Fitting Tightening Tool, Aluminum	ea	30



UHPLC Column Fittings (Over 19,000 psi)

Ultra-High Performance Stainless Steel Nut and Ferrule Set

For ultra-high pressure connections use this specially-designed 10-32 stainless steel nut and ferrule set. The metal ferrule cuts a ring near the end of the tube to swage the fitting to the tube, and will provide a maximum operational limit of

28,000 psi (1,930 bar). Seating (swaging) the fitting usually takes only about a ¼ turn beyond the point where the ferrule first starts to grab the tubing.



Pressure rated up to 28,000 psi (1,930 bar)

Ordering Information

Part No.	Description	Unit	Price
AQ0-8506	Nut and Ferrule Set, SS, 10-32, for ¼ in. Tubing, 28,000 psi (1,930 bar)	10/pk	\$ 215

Important: To achieve the maximum pressure rating, 45 lbs of torque is required.

UHPLC/ HPLC Sure-Lok™ High Pressure PEEK Male Nut Fittings

Made of a proprietary PEEK blend, these ultra-high performance polymeric fittings are perfect for all extreme high-pressure applications, and best for ion- and bio-chromatography. For ¼ in. diameter tubing, there are two design types. The convenient one-piece design is pressure rated to 12,000 psi (827 bar) and stable up to temperatures of 200 °C. The second type is engineered as a 3-piece unit, with a ferrule and stainless steel gripping ring that will provide leak-free connections up to 19,000 psi (1,310 bar). For higher pressure-rated fittings use the stainless steel nut and ferrule set (AQ0-8506).

Ordering Information

Part No.	Description	Unit	Price
AQ0-8503	Sure-Lok High Pressure PEEK 1-Pc Nut, 10-32, for ¼ in. Tubing, 12,000 psi (827 bar) **	10/pk	\$ 189
AQ0-8504	Sure-Lok High Pressure PEEK Nut, 10-32, for ¼ in. Tubing, 19,000 psi (1,310 bar) ***	10/pk	\$ 147
AQ0-8505	Sure-Lok PEEK Ferrule Assembly (2-pc), for High Pressure 2-Pc Nut (AQ0-8504)	10/pk	\$ 110

*Ferrule assembly (AQ0-8505) must be ordered separately.

**Sure-Lok Fitting Tightening Tool (AQ0-8530) is required for AQ0-8503 and AQ0-8504

Quick Use Notes for AQ0-8504 and AQ0-8505

Slide the nut (AQ0-8504), steel ring and PEEK ferrule on the tube, in that order.

Important! The side of the ring with the wider flat surface should face toward the nut, and the narrow-edged side of the ring toward the ferrule.



AQ0-8503
Pressure rated up to 12,000 psi (827 bar)



AQ0-8504 shown with AQ0-8505
Pressure rated up to 19,000 psi (1,310 bar)

Essential High Pressure Fitting Tool

Use this handy tool to tighten any standard, short- or long-style knurl-headed (high pressure) male nut like the Sure-Lok™ polymeric ones shown above. The tool can also be used with many of the low-pressure nuts commonly used in the lab.

Ordering Information

Part No.	Description	Unit	Price
AQ0-8530	Sure-Lok Fitting Tightening Tool, Aluminum	ea	\$ 30

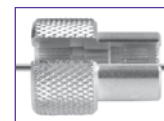

Ultra-High Performance Stainless Steel Zero Dead-Volume Union

Stainless Steel Construction, Pressure Rated to 28,000 psi (1,930 bar)

- For ¼ in. OD tubing, with 10-32 threading
- 0.010 in. thru hole, 20 nL swept volume
- Includes 2 fittings (nuts and ferrules)

Ordering Information

Part No.	Description	Unit	Price
AQ0-8507	Zero Dead Volume Union, SS, with Fittings, 10-32, for ¼ in. Tubing, 28,000 psi (1,930 bar)	ea	75



Pressure rated up to 28,000 psi (1,930 bar)



UHPLC Column Protection

Prevent damaging micro-particulates, system particles, and bacterial contaminants from entering your UHPLC column and detector.

Why is column protection important?

UHPLC columns utilize smaller particles that are easily affected by dirty, unfiltered samples or mobile phases. Column protection systems prevent sample and mobile phase particulates and contaminants from building up at the head of the column, which can otherwise degrade chromatography, increase system backpressure, and shorten column lifetime. Column protection systems also safeguard UHPLC columns and detectors from shedding pump and rotor seal particulates.

With SecurityGuard ULTRA



Inlet Frit



Column Media

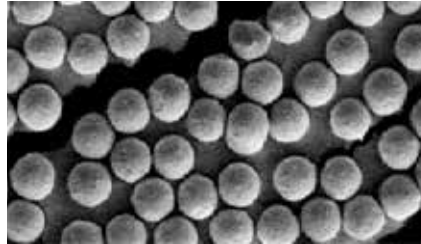

(24000 times magnification)

Without SecurityGuard ULTRA



Inlet Frit



Column Media



Scanning electron microscopy of column inlet frit

Contaminant and particle buildup



How does UHPLC column protection work?

Column protection systems protect your UHPLC columns and detectors from micro-particulates in the sample, solvent, or wear on the polymeric seals of the pump or injector. These protection products trap particulates before they can reach the column or detector. Contaminants can clog frits, irreversibly bind to column packings, degrade analytical performance, and even damage expensive detector flow cells.

The SecurityGuard™ ULTRA column protection system protects virtually any core-shell and/or $3\ \mu\text{m}$ particle columns (pressures <math>< 20,000\ \text{psi}/1370\ \text{bar}</math>) and detector flow cells by trapping both particulates and chemical contaminants with inexpensive disposable packed cartridges. Short cartridge lengths protect your HPLC columns without altering chromatography.

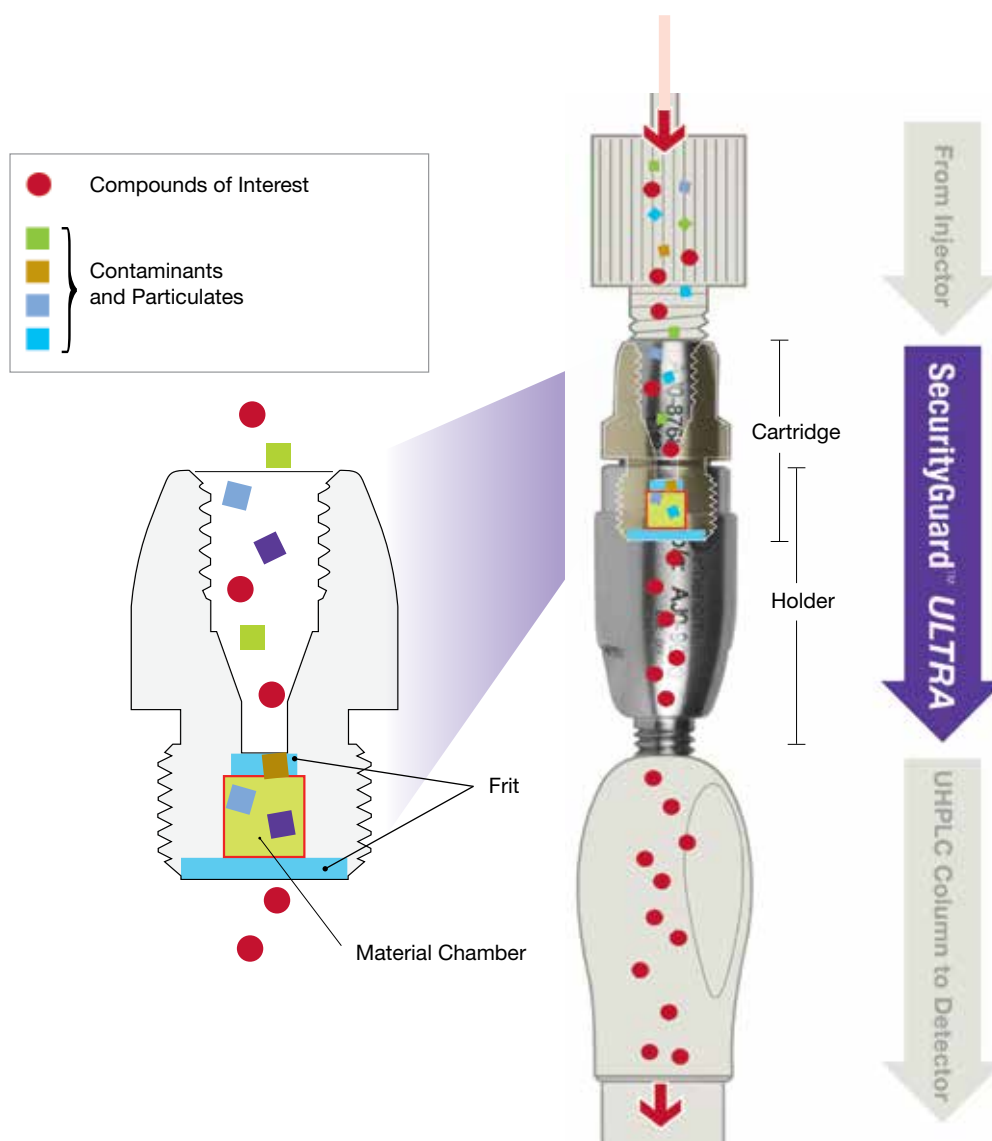



SecurityGuard ULTRA UHPLC Column Protection

The SecurityGuard ULTRA cartridge traps both chemical contaminants and particulates. Once the cartridge is exhausted, simply replace it instead of your expensive column investment. The universal holder provides a leak-free connection to virtually any UHPLC column.

You will experience:

- Extended UHPLC, core-shell, and < 3 µm column lifetimes
- More consistent UHPLC column performance
- Less troubleshooting downtime
- Overall cost savings

When contaminants and particulates build up at the head of the column or on the guard cartridges, system pressures will dramatically increase.

By simply replacing the SecurityGuard ULTRA cartridge instead of your sub-2 µm or core-shell UHPLC column, you are able to regain normal operating conditions and reclaim original column performance, as illustrated in the figure below.

SecurityGuard ULTRA Performance

In this accelerated column lifetime test, the UHPLC column lasts substantially longer with SecurityGuard ULTRA guard cartridge system.

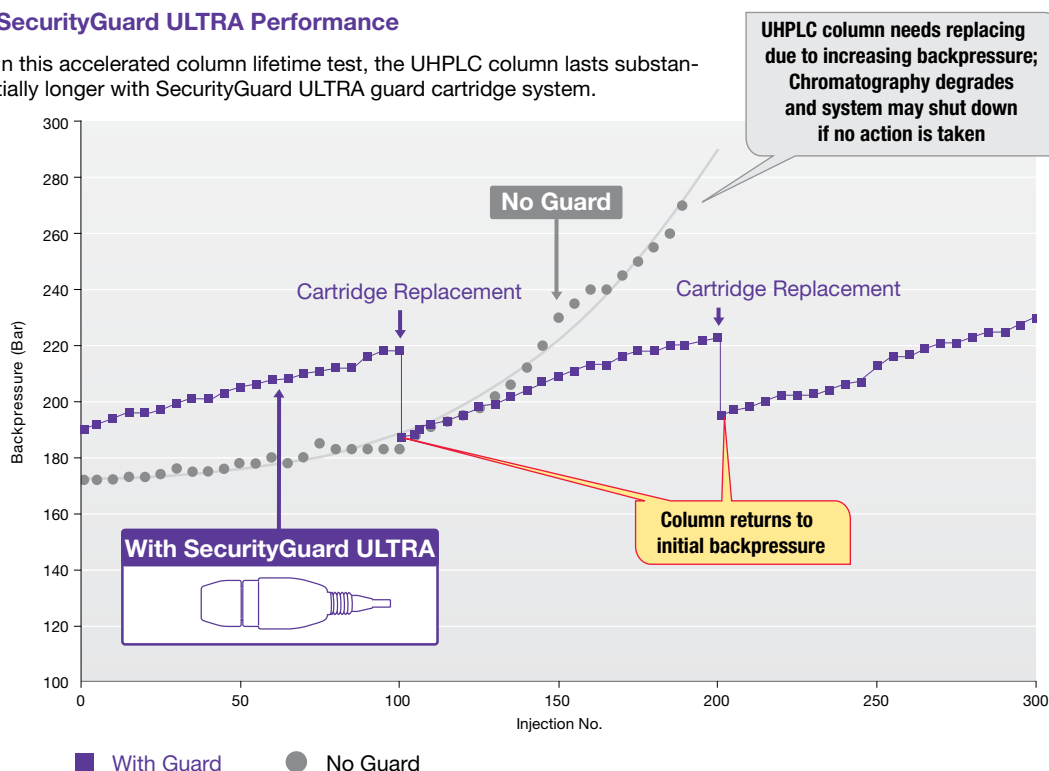

Accelerated lifetime test using endogenous biological matrix on Kinetex® 2.6 µm C18 50 x 4.6 mm ID column.



Ordering Information



SecurityGuard ULTRA Cartridges

Material	Description	pH Stability	Column ID (mm)		
			2.1	3.0	4.6
Cartridges for General Purpose/ Pharmaceutical			\$ 405/3pk	\$ 405/3pk	\$ 405/3pk
C18	(ODS, Octadecyl)	1.5 – 8.5*	AJO-8782	AJO-8775	AJO-8768
C8	(MOS, Octyl)	1.5 – 8.5*	AJO-8784	AJO-8777	AJO-8770
PFP	(Pentafluorophenyl)	1.5 - 8.5*	AJO-8787	AJO-8780	AJO-8773
HILIC	(HILIC)	2.0 - 7.5	AJO-8786	AJO-8779	AJO-8772
Biphenyl	(Biphenyl)	1.5 – 8.5*	AJO-9209	AJO-9208	AJO-9207
Cartridges for Protein and Peptide Reversed Phase					
Widepore C18	(ODS, Octadecyl)	1.5 – 8.5*	AJO-8783	–	AJO-8769
Widepore C8	(MOS, Octyl)	1.5 – 8.5*	AJO-8785	–	AJO-8771
Widepore C4	(Butyl)	1.5 – 8.5*	AJO-8899	–	AJO-8901
Peptide C18	(ODS, Octadecyl)	1.5 – 8.5*	AJO-8948	–	AJO-8946

2012 R&D 100
Award Recipient



*pH stable 1.5 - 8.5 under gradient conditions. pH stable 1.5 - 10 under isocratic conditions.

SecurityGuard ULTRA Holder



Part No.	Description	Unit	Unit
AJO-9000	SecurityGuard ULTRA Cartridge Holder	ea	\$ 105

AJO-9000 is the universal holder designed for use with 2.1 mm, 3.0mm and 4.6mm ID cartridges.

Designed for use with all core-shell and/or < 3µm particle columns (< 20,000 psi / 1,378 bar)



Need assistance selecting the most appropriate column protection?

Use your online web tool to find the perfect guard column. Visit:

www.phenomenex.com/GuardIt



Bottle Filter Caps
p. 22

Solvent Pickup Adapter
p. 21



Phenex™
Filter Membranes
p. 20

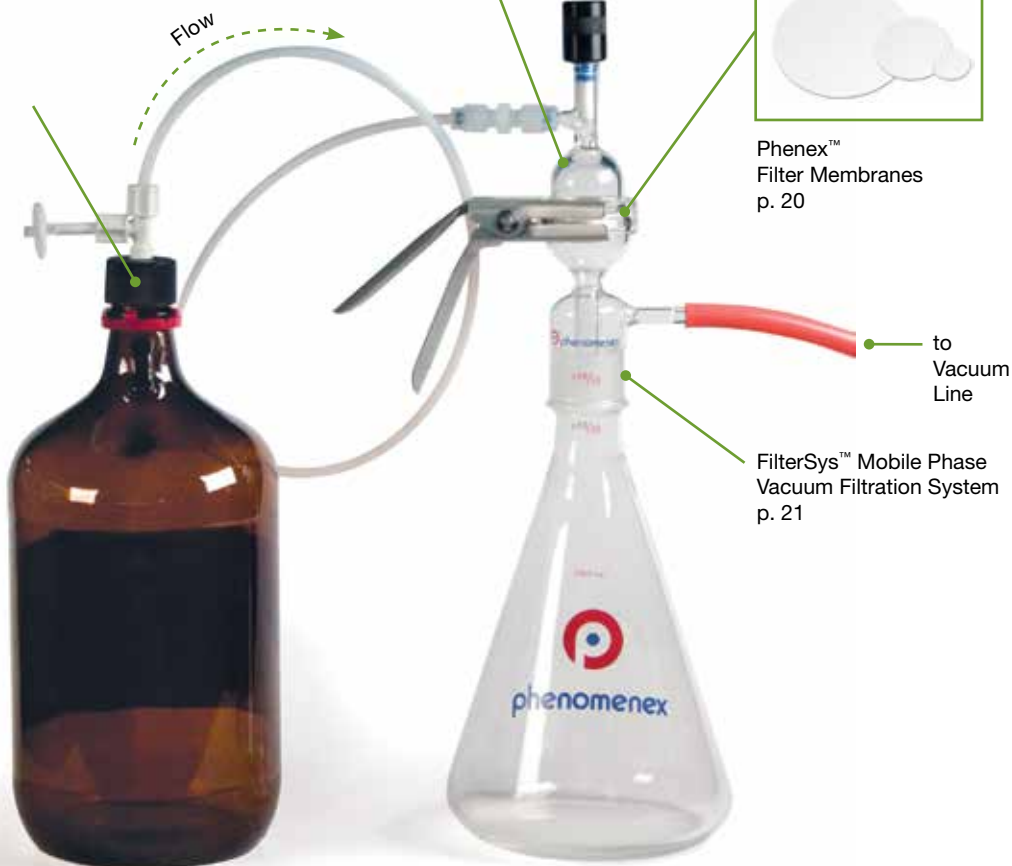

Unfiltered Solvent

Filtered Solvent

to Vacuum Line

FilterSys™ Mobile Phase
Vacuum Filtration System
p. 21

Valve Caps
p. 22

to HPLC Pump



Inlet Filter
p. 23



HPLC Mobile Phase
Reservoir
p. 22



Mobile Phase Filtration

Protect your UHPLC chromatographic equipment from mobile phase contaminants that can damage system components and produce poor results.

Why is UHPLC mobile phase filtration important?

Unfiltered or low quality mobile phase may contain particulates and bacterial contaminants that can build up and create a chain reaction of UHPLC system and column problems. Check valves, pump seals and the injector may be damaged by particulates passing through tight, low-dead volume systems. Once these particulates reach your UHPLC column, the buildup will result in pressure increases, causing the system to work harder, damaging the pump, or even shutting your system down. Trace amounts of mobile phase contaminants can also produce split peaks or extraneous unidentifiable peaks, leading to unacceptable results.

Note: for UHPLC/MS applications it may not be necessary to filter the organic solvents (Acetonitrile and Methanol) assuming one is already using ultra high purity solvents, as this may introduce ultra low levels of trace impurities.

How does UHPLC mobile phase filtration work?

There are two convenient ways to transfer solvents for filtration.

- A pickup adapter can be used to directly feed the solvent from the source container into the filtration system (part number AH0-2947)
- A funnel can be used to hold and transfer the solvent for filtration (see page 21).

Either way, solvents are passed through a 47 mm diameter Phenex™ filter membrane (0.2 μm recommended for UHPLC) which is placed between the FilterSys™ mobile filtration system's fritted glass support base and the sample reservoir. The filtered, particulate-free solvents are then stored in plasticizer-free glass reservoirs for delivery to the chromatographic system. When the filtered solutions are ready for use, a solvent inlet filter (see page 23) placed in the mobile phase reservoir helps to remove any buffer salts that may have precipitated or any bacterial growth that has occurred before they enter the system.

Together, this system allows for the rapid filtration of particulate matter along with the removal of undissolved buffer salts from your solvents.





Mobile Phase Filtration

Remove particulates from solvents

Phenex™ Filter Membranes reduce sample preparation times and improve chromatography in one step by filtering solvents.

- Wide selection of membrane sizes and types
- Virtually free of unwanted plasticizers or contaminants
- Excellent chemical resistance to most laboratory solvents

Choose the proper membrane type for your analysis:

Regenerated Cellulose (RC) is recommended for general filtration, de-gassing solvents, and HPLC mobile phases (both aqueous and organic)

Nylon (NY) is hydrophilic and makes the filtering of aqueous solvents simple, without pre-wetting

Polytetrafluoroethylene (PTFE, Teflon®) is hydrophobic and is recommended for the filtration of non-aqueous solutions

Polyethersulfone (PES) has excellent flow speeds with a wide pH range (2-12) for aggressive solvents

Cellulose Acetate (CA) is recommended for buffers and other aqueous solutions

Cellulose Nitrate Ester (MCE)* is recommended for particle collection, sample pre-treatment, and chemotaxis



Ordering Information

Part No.	Pore Size (µm)	Disc Diameter (mm)	Membrane Material	Unit	Price
Regenerated Cellulose (RC)					
AF0-8440	0.45	13	RC	100/pk	\$ 110
AF0-8441	0.2	13	RC	100/pk	110
AF0-8442	0.2	25	RC	100/pk	130
AF0-8443	0.45	47	RC	100/pk	165
AF0-8444	0.2	47	RC	100/pk	165
PTFE (Teflon®)					
AF0-0509	0.2	13	PTFE	100/pk	\$ 135
AF0-0511	0.2	25	PTFE	100/pk	135
AF0-0512	0.45	25	PTFE	100/pk	135
AF0-0513	0.2	47	PTFE	100/pk	185
AF0-0514	0.45	47	PTFE	100/pk	185
Cellulose Acetate (CA)					
AF0-8436	0.45	25	CA	100/pk	\$ 95
AF0-8437	0.2	25	CA	100/pk	95
AF0-8438	0.45	47	CA	100/pk	105

Part No.	Pore Size (µm)	Disc Diameter (mm)	Membrane Material	Unit	Price
AF0-8439	0.2	47	CA	100/pk	105
Nylon (NY)					
AF0-0500	0.45	13	Nylon	100/pk	\$ 135
AF0-0501	0.2	25	Nylon	100/pk	135
AF0-0502	0.45	25	Nylon	100/pk	135
AF0-0503	0.2	47	Nylon	100/pk	145
AF0-0504	0.45	47	Nylon	100/pk	145
Polyethersulfone (PES)					
AF0-8445	0.2	25	PES	100/pk	\$ 130
AF0-8446	0.45	25	PES	100/pk	130
AF0-8447	0.2	47	PES	100/pk	179
AF0-8448	0.45	47	PES	100/pk	179
Cellulose Nitrate Ester (MCE)*					
AF0-8454	0.45	47	MCE	100/pk	\$ 145



Above filter membranes are non-sterile.

*MCE = mixed cellulose esters



Mobile Phase Filtration

FilterSys™ Mobile Phase Vacuum Filtration System

- Rapid filtration of buffers, organics and corrosive liquids
- Prevents pump and system component damage
- Removes damaging microparticulates and bacterial contaminants

Ordering Information

Part No.	Description	Unit	Price
Complete Assembly			
AHO-1566	FilterSys, 47 mm, 300 mL funnel with 1 L vacuum flask	ea	\$ 359
AHO-3314	FilterSys, 47 mm, 500 mL funnel with 2 L vacuum flask	ea	479
AHO-3315	FilterSys, 47 mm, 1000 mL funnel with 4 L vacuum flask	ea	499
Component Parts			
AHO-1567	Fritted support base, 47 mm, 40/35 taper	ea	\$ 235
AHO-1568	Funnel, graduated, 300 mL, 47 mm	ea	109
AHO-3323	Funnel, graduated, 500 mL, 47 mm	ea	115
AHO-3324	Funnel, graduated, 1000 mL, 47 mm	ea	139
AHO-1569	1 liter filter flask, 40/35 taper	ea	155
AHO-3321	2 liter filter flask, 40/35 taper	ea	179
AHO-3322	4 liter filter flask, 40/35 taper	ea	209
AHO-1570	Aluminum clamp, 47 mm	ea	85

**WARNING:**

The apparatus should be used with a water aspiration line, not a true vacuum line, unless secured behind an appropriate safety shield.



Solvent Pickup Adapter

Use filter membranes with this rapid filtration system!

This glass adapter enables direct pickup of mobile phase solvent using the Phenomenex FilterSys™. It replaces the tedious and dangerous pour-and-wait funnel filtration method by drawing solvent directly from the reagent bottle, which is the safest way to transfer and filter solvents.

- 4 mm PTFE stopcock with ¼ in. OD outlet
- PTFE connector with compression fittings for ¼ in. OD tubing
- 3 feet of ¼ in. OD PTFE tubing

Ordering Information

Solvent Pickup Adapter			
Part No.	Description	Unit	Price
AHO-2947	Mobile Phase Pickup Adapter, 47 mm	ea	\$ 155





HPLC Mobile Phase Reservoir

- Low-leaching (low alkali), borosilicate glass
- Chemically inert (no plasticizers), internal PTFE seal

Ordering Information

Reservoir and Valve Cap Assembly			
Part No.	Description	Unit	Price
AHO-4142	HPLC Reservoir, 1000 mL clear glass, GL45 wide-mouth, includes 3-way Valve Cap	ea	\$ 239
AHO-4143	HPLC Reservoir, 2000 mL clear glass, GL45 wide-mouth, includes 3-way Valve Cap	ea	249



Replacement Valve Cap

For GL45 Neck Mobile Phase Reservoirs

- Valve caps provide an inert PTFE (Teflon®) seal against the solvents inside. An all-Teflon block design with stainless steel heli-coils grips the Teflon tubing.
- Supplied with 1/8 in. fitted tubes, will not twist when tightened
- Pressure rated to 15 psi (1 bar) and autoclavable

Ordering Information

Replacement Valve Cap for GL45 Threaded Bottles			
Part No.	Description	Unit	Price
AHO-4141	3-Way Valve Cap, GL45 threads, solid PTFE (Teflon®) block construction	ea	\$ 205



Bottle Filter Cap

Reduce solvent evaporation and gas absorption

Bottle filter caps ensure constant pH levels and increase chromatography reproducibility by minimizing the reabsorption of dissolved gases back into the solvent

- All cap parts are compatible with most common HPLC solvents
- Neatly seals to prevent particulates from entering the solvent bottle

Ordering Information

Filter Cap				
Part No.	Description	Cap Size	Unit	Price
AHO-1565	Filter Reservoir Cap	38 mm	ea	\$ 95





Inlet Filters

Protect HPLC pump heads and check valves

The Solvent Saver™ Inlet Filters minimize costly system repairs and reduce system downtime by filtering solvents before analysis. Phenomenex offers two types of solvent inlet filters to fit your analysis: Metal-Free/Biocompatible and Stainless Steel.

Metal-Free / Biocompatible

This is a great choice for sensitive biochromatography and ion chromatography applications where metal surfaces may corrode or interact with samples.

- Flat bottom design uses all available mobile phase
- High surface area for long filter life



Universal fit adapter (sold separately AQ0-8339) slip-fits onto 1.5, 2.2 or 3.0 mm ID tubing

1/4 in.-28 flangeless fitting (included) attaches to 1/8 in. OD tubing

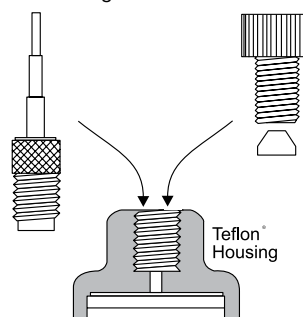

Ordering Information

Solvent Saver Inlet Filter - Metal-Free			
Part No.	Description	Unit	Price
AH0-1562	Solvent Saver Inlet Filter with 10 µm PEEK filter with Flangeless fitting for 1/8 in. OD tubing	ea	\$ 115
AQ0-8339	Solvent Saver Unifit Adapter, Tri-Step Tubing Connector, PEEK	ea	35
AQ0-2949	Flangeless Nut and Ferrule for 1/16 in. OD tubing, 1/4 in.-28 threads, red Delrin®	10/pk	50
AQ0-2950	Flangeless Nut and Ferrule for 1/8 in. OD tubing, 1/4 in.-28 threads, green Delrin	10/pk	50
AT0-2953	Teflon Tubing, 5 ft. L x 1/16 in. OD x 1/32 in. (0.031 in.) ID	ea	40
AT0-2955	Teflon Tubing, 5 ft. L x 1/8 in. OD x 1/16 in. (0.062 in.) ID	ea	40

Stainless Steel

The best option for general applications that use non-corrosive chemicals.

- Protects pumps and check valves
- Easy to replace
- Low cost

Ordering Information

Solvent Inlet Filters - Stainless Steel			
Part No.	Description	Unit	Price
AF0-0356	Solvent Inlet Filter, 2 µm, for 1/16 in. ID tubing	ea	\$ 55
AF0-0359	Solvent Inlet Filter, 2 µm, for 1/8 in. ID tubing	ea	55
AT0-2953	Teflon Tubing, 5 ft. L x 1/16 in. OD x 1/32 in. (0.031 in.) ID	ea	40
AT0-2955	Teflon Tubing, 5 ft. L x 1/8 in. OD x 1/16 in. (0.062 in.) ID	ea	40



UHPLC Column and System Protection Essentials

Australia

t: 02-9428-6444
f: 02-9428-6445
auinfo@phenomenex.com

Austria

t: 01-319-1301
f: 01-319-1300
anfrage@phenomenex.com

Belgium

t: 02 503 4015 (French)
t: 02 511 8666 (Dutch)
f: +31 (0)30-2383749
beinfo@phenomenex.com

Canada

t: (800) 543-3681
f: (310) 328-7768
info@phenomenex.com

Denmark

t: 4824 8048
f: +45 4810 6265
nordicinfo@phenomenex.com

Finland

t: 09 4789 0063
f: +45 4810 6265
nordicinfo@phenomenex.com

France

t: 01 30 09 21 10
f: 01 30 09 21 11
franceinfo@phenomenex.com

Germany

t: 06021-58830-0
f: 06021-58830-11
anfrage@phenomenex.com

India

t: 040-3012 2400
f: 040-3012 2411
indiainfo@phenomenex.com

Ireland

t: 01 247 5405
f: +44 1625-501796
eireinfo@phenomenex.com

Italy

t: 051 6327511
f: 051 6327555
italiainfo@phenomenex.com

Luxembourg

t: +31 (0)30-2418700
f: +31 (0)30-2383749
nlinfo@phenomenex.com

Mexico

t: 001-800-844-5226
f: 001-310-328-7768
tecnicomx@phenomenex.com

The Netherlands

t: 030-2418700
f: 030-2383749
nlinfo@phenomenex.com

New Zealand

t: 09-4780951
f: 09-4780952
nzinfo@phenomenex.com

Norway

t: 810 02 005
f: +45 4810 6265
nordicinfo@phenomenex.com

Puerto Rico

t: (800) 541-HPLC
f: (310) 328-7768
info@phenomenex.com

Sweden

t: 08 611 6950
f: +45 4810 6265
nordicinfo@phenomenex.com

United Kingdom

t: 01625-501367
f: 01625-501796
ukinfo@phenomenex.com

United States

t: (310) 212-0555
f: (310) 328-7768
info@phenomenex.com

All other countries: Corporate Office USA

t: (310) 212-0555
f: (310) 328-7768
info@phenomenex.com



www.phenomenex.com

Phenomenex products are available worldwide. For the distributor in your country, contact Phenomenex USA, International Department at international@phenomenex.com

Terms and Conditions

Subject to Phenomenex Standard Terms and Conditions which may be viewed at www.Phenomenex.com/TermsAndConditions

Trademarks

Kinetex is a registered trademark, and Phenex, SecurityGuard, FilterSys, Solvent Saver, Sure-Lok, and Verex are trademarks of Phenomenex. PEEKsil is a trademark of SGE. Agilent is a registered trademark of Agilent Technologies, Inc. Thermo Scientific is a registered trademark of Thermo Fisher Scientific Inc. Waters is a registered trademark of Waters Corp. Cylolite is a registered trademark of CY/RO Industries. Teflon is a registered trademark of E.I. du Pont de Nemours and Co.

Disclaimer

Phenomenex is in no way affiliated with Barilla or U.S. Silica Co. Comparative separations may not be representative of all applications.

© 2014 Phenomenex, Inc. All rights reserved.